

# AS1355

## 300mA, Triple LDO

### 1 General Description

The AS1355 is a high-performance triple CMOS low-dropout voltage regulator in a single QFN package. The efficient set of programmable power supplies is optimized to deliver the best compromise between quiescent current and regulator performance for mobile phones, PDAs, MP3 players, and other battery powered devices.

Stability is guaranteed with ceramic output capacitors of only 1µF ( $\pm 20\% - X5R$ ) up to 4.7µF ( $\pm 20\% - X5R$ ). The low equivalent series resistance (ESR) of these capacitors ensures low output impedance at high frequencies.

Regulation performance is excellent even under low dropout conditions, when the power transistor has to operate in linear mode.

The low-noise performance allows direct connection of noise sensitive circuits without additional filtering networks.

The AS1355 is available in a 16-pin QFN 3x3 package.

### 2 Key Features

- n 3 Independent Voltage Regulators with Shutdown
- n Output Current: 300mA each LDO
- n Programmable Output Voltage Range: 1.25V to 3.6V in 50mV Steps
- n Accuracy:  $\pm 1.0\%$
- n PSRR: 70dB at 1kHz, 60dB at 100kHz
- n Load Regulation: 3mV (0 to 300mA)
- n Supply Range: 2.3V to 5.5V
- n 0.1V Dropout Voltage @ Iload = 200mA
- n Shutdown Current:  $\leq 1\mu A$
- n Supply Current Without Load: 160µA
- n Softstart for Low Inrush Current
- n Stable with low ESR Ceramic Capacitors from 1µF to 4.7µF
- n Low Noise: 40µV rms @10Hz to 100kHz Bandwidth
- n Thermal Protection
- n Over-Current Protection
- n Temperature Range: -40°C to +85°C
- n 16-pin QFN 3x3 Package

### 3 Applications

The AS1355 is ideal for cordless and mobile phones, MP3 players, CD and DVD players, PDAs, hand-held computers, digital cameras, and any other hand-held battery-powered device.

Figure 1. AS1355 - Typical Application Diagram

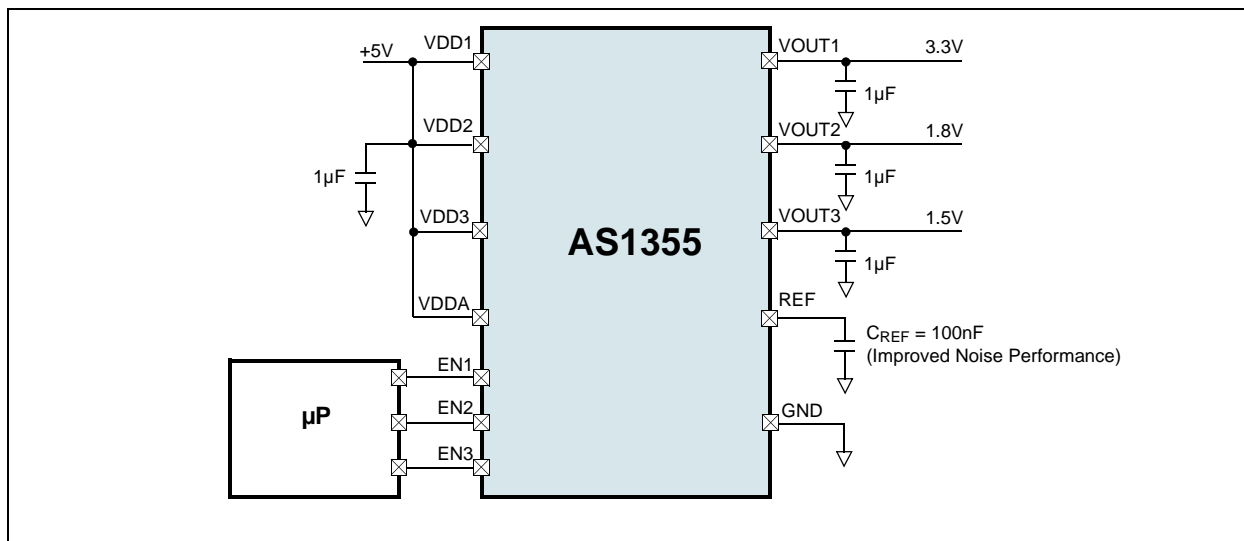

## 4 Pinout

### Pin Assignments

Figure 2. Pin Assignments (Top View)

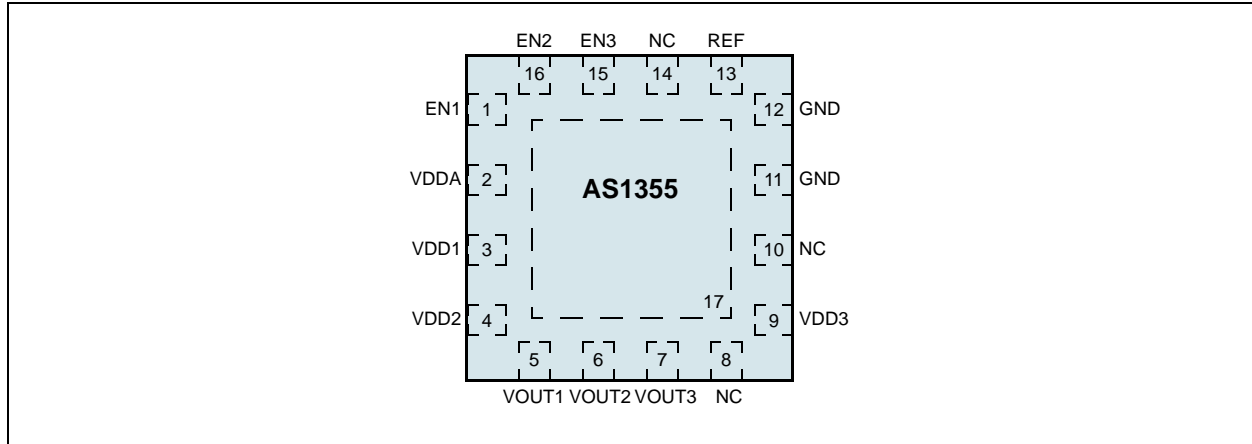

### Pin Descriptions

Table 1. Pin Descriptions

Pin Number	Pin Name	Description
1	EN1	Active-High Enabel Input 1. Pull this pin to GND to disable the regulated output voltage VOUT1.
2	VDDA	Analog Power Supply Voltage
3	VDD1	Unregulated Input Voltage 1
4	VDD2	Unregulated Input Voltage 2
5	VOUT1	Regulated Output Voltage 1
6	VOUT2	Regulated Output Voltage 2
7	VOUT3	Regulated Output Voltage 3
8	NC	Not Connected
9	VDD3	Unregulated Input Voltage 3
10	NC	Not Connected
11, 12	GND	Ground. <b>Note:</b> All GND pins must be connected together externally.
13	REF	Reference Voltage. <b>Note:</b> Connect to a 100nF capacitor during normal operation.
14	NC	Not Connected
15	EN3	Active-High Enabel Input 3. Pull this pin to GND to disable the regulated output voltage VOUT3.
16	EN2	Active-High Enabel Input 2. Pull this pin to GND to disable the regulated output voltage VOUT2.
17	NC	Exposed Pad. This pad is not connected internally, it can be connected to GND.

## 5 Absolute Maximum Ratings

Stresses beyond those listed in [Table 2](#) may cause permanent damage to the device. These are stress ratings only, and functional operation of the device at these or any other conditions beyond those indicated in the operational sections of the specifications is not implied. Exposure to absolute maximum rating conditions for extended periods may affect device reliability.

Table 2. Absolute Maximum Ratings

Parameter	Min	Max	Units	Comments
<b>Electrical Parameters</b>				
VDDx, ENx to GND	-0.3	7	V	
VOU Tx to GND	-0.3	5	V	
All other pins to GND	-0.3	V <sub>DD</sub> + 0.3	V	
<b>Electrostatic Discharge</b>				
Electrostatic Discharge HBM	2		kV	Norm: MIL 883 E method 3015
<b>Temperature Ranges and Storage Conditions</b>				
Thermal Resistance $\Theta_{JA}$		33	°C/W	on PCB
Junction Temperature		+125	°C	
Storage Temperature Range	-55	+125	°C	
Package Body Temperature		+260	°C	The reflow peak soldering temperature (body temperature) specified is in accordance with <i>IPC/JEDEC J-STD-020 "Moisture/Reflow Sensitivity Classification for Non-Hermetic Solid State Surface Mount Devices"</i> .
Humidity non-condensing	5	85	%	
Moisture Sensitive Level	3			Represents a max. floor life time of 168h

## 6 Electrical Characteristics

$V_{DD} = 4V$ ,  $C_{OUT} = 1\mu F$ ,  $T_{AMB} = -40^{\circ}C$  to  $+85^{\circ}C$  (Typ values are for  $T_{AMB} = 25^{\circ}C$ ), unless otherwise specified.

Table 3. Electrical Characteristics

Symbol	Parameter	Conditions	Min	Typ	Max	Unit
TAMB	Operating Temperature Range		-40		85	°C
VDD	Supply Voltage Range		2.3		5.5	V
VOUT	Output Voltage Range		1.25		3.6	V
RON	On Resistance			0.5		Ω
PSRR <sup>1</sup>	Power Supply Rejection Ratio	f = 1kHz, CREF = 100nF		70		dB
		f = 100kHz, CREF = 100nF		60		
I <sub>OFF</sub>	Shut Down Current	ENx = Low, TAMB = +25°C			1	μA
I <sub>VDD</sub>	Supply Current	Without Load		160	240	μA
t <sub>set</sub> <sup>1</sup>	Output Voltage Settling Time	I <sub>LOAD</sub> Switched from 0 to 100mA			50	μs
t <sub>start</sub> <sup>1</sup>	Start-up Time <sup>2</sup>	CREF = 100nF Pre-charged			300	μs
		CREF = 0nF Uncharged		200		μs
		CREF = 100nF Uncharged		15		ms
V <sub>OUT</sub>	Output Voltage Tolerance	I <sub>LOAD</sub> = 0mA, TAMB = 25°C	-1		1	%
		I <sub>LOAD</sub> = 0mA	-2		2	%
V <sub>LINE</sub> REG	Line Regulation, Static	V <sub>OUT(NOM)</sub> +0.3V to 5.5V	-1		1	%
V <sub>LOAD</sub> REG <sup>1</sup>	Load Regulation, Static	I <sub>LOAD</sub> = 0 to 50 mA		0.5	2.5	mV
		I <sub>LOAD</sub> = 0 to 300 mA		3	10	mV
V <sub>IH</sub>	Enable Input Voltage High		1.5			V
V <sub>IL</sub>	Enable Input Voltage Low				0.4	V
I <sub>LOAD</sub>	Output Current		0		300	mA
I <sub>LIMIT</sub>	Output Current Limitation			450		mA
V <sub>Noise</sub>	Output Noise Voltage	10Hz to 100kHz, CREF = 100nF		40		μV <sub>RMS</sub>
	Thermal Protection			150		°C

1. Guaranteed by design and verified by lab evaluation.
2. Startup is performed if any EN pin goes high.

**Note:** All limits are guaranteed. The parameters with min and max values are guaranteed with production tests or SQC (Statistical Quality Control) methods.

## 7 Typical Operating Characteristics

$V_{DD} = 4V$ ,  $V_{OUT} = 3.3V$ ,  $C_{OUT} = 1\mu F$ ,  $T_{AMB} = +25^{\circ}C$  (unless otherwise specified);

Figure 3. Load Regulation;  $V_{OUT}$  vs.  $I_{OUT}$

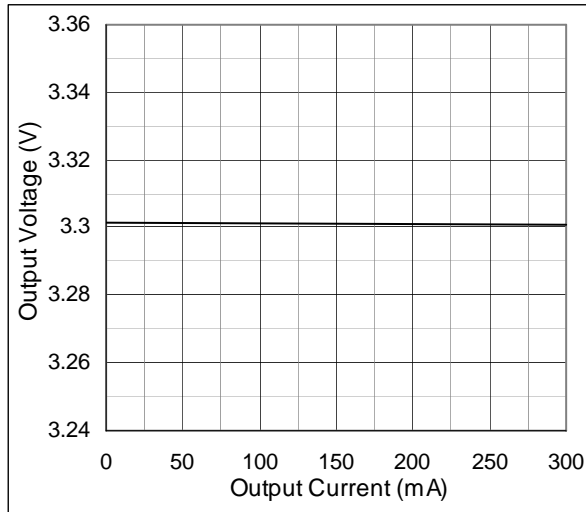

Figure 4. Line Regulation;  $V_{OUT}$  vs.  $V_{IN}$

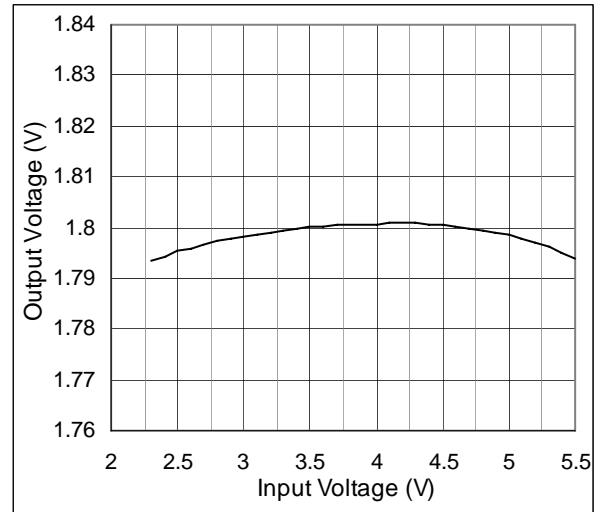

Figure 5. Output Voltage vs. Temp.;  $I_{OUT} = 1mA$

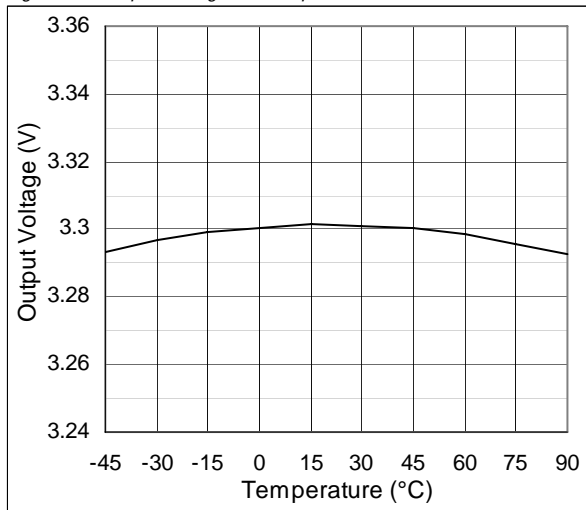

Figure 6. Quiescent Current vs. Temperature

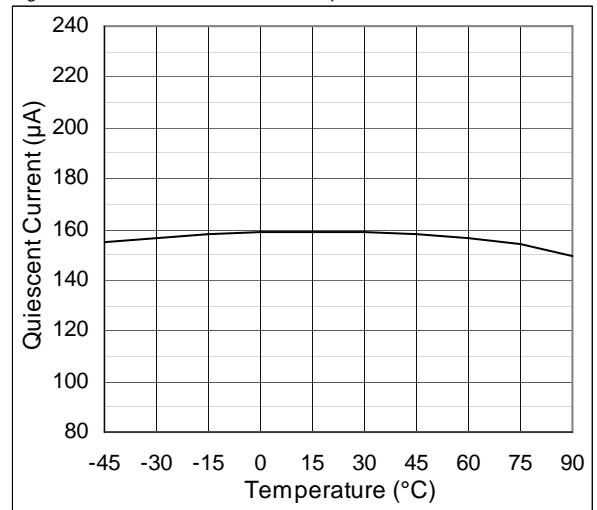

Figure 7. Startup; no Load, no  $C_{REF}$

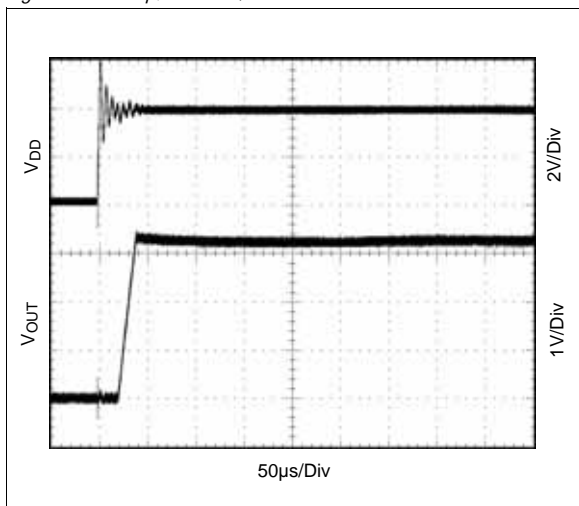

Figure 8. Startup;  $R_{LOAD} = 11\Omega$ , no  $C_{REF}$

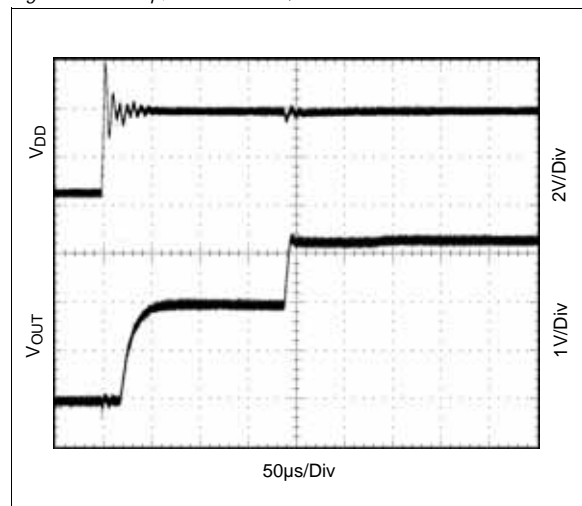

Figure 9. Startup; no Load,  $C_{REF} = 100nF$

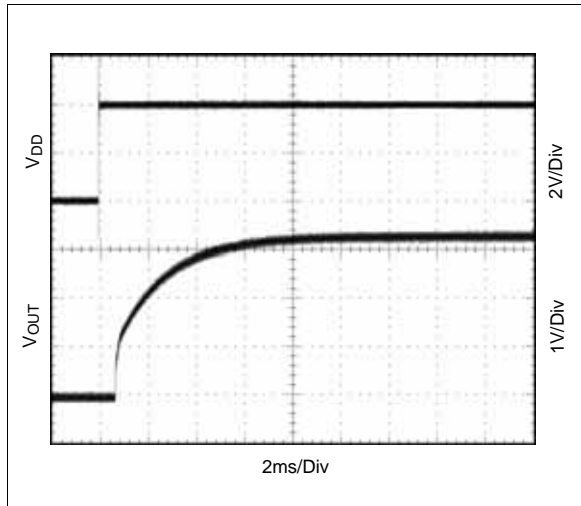

Figure 10. Startup;  $R_{LOAD} = 11\Omega$ ,  $C_{REF} = 100nF$

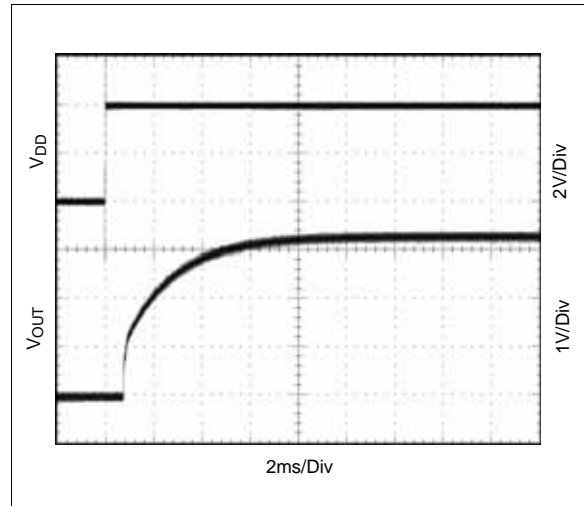

Figure 11. Startup; no Load,  $C_{REF} = 100nF$  (pre-charged)

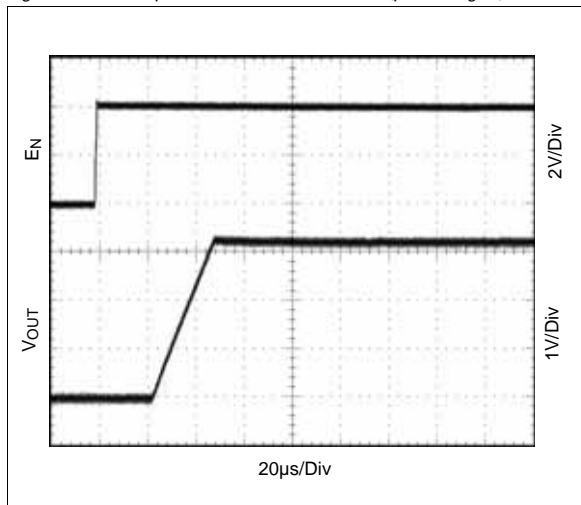

Figure 12. Startup;  $R_{LOAD} = 11\Omega$ ,  $C_{REF} = 100nF$  (pre-charged)

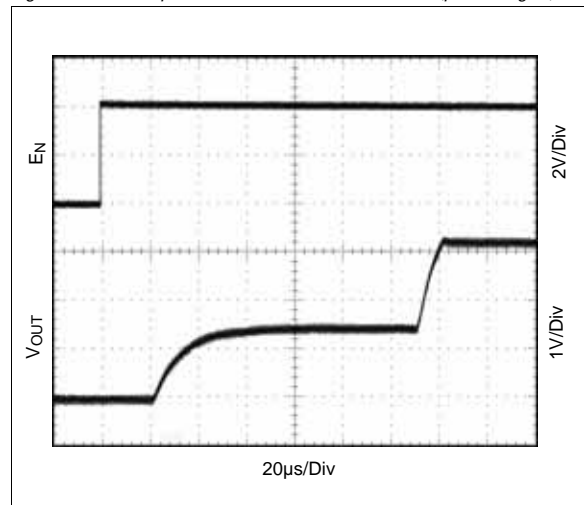

Figure 13. Load Transient Response;  $I_{OUT} = 0$  to  $300mA$

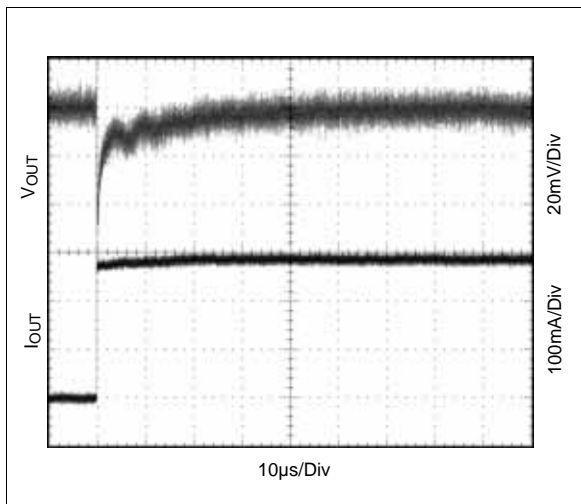
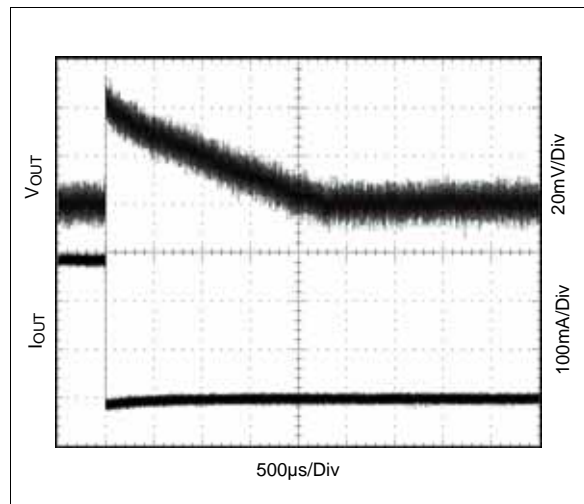
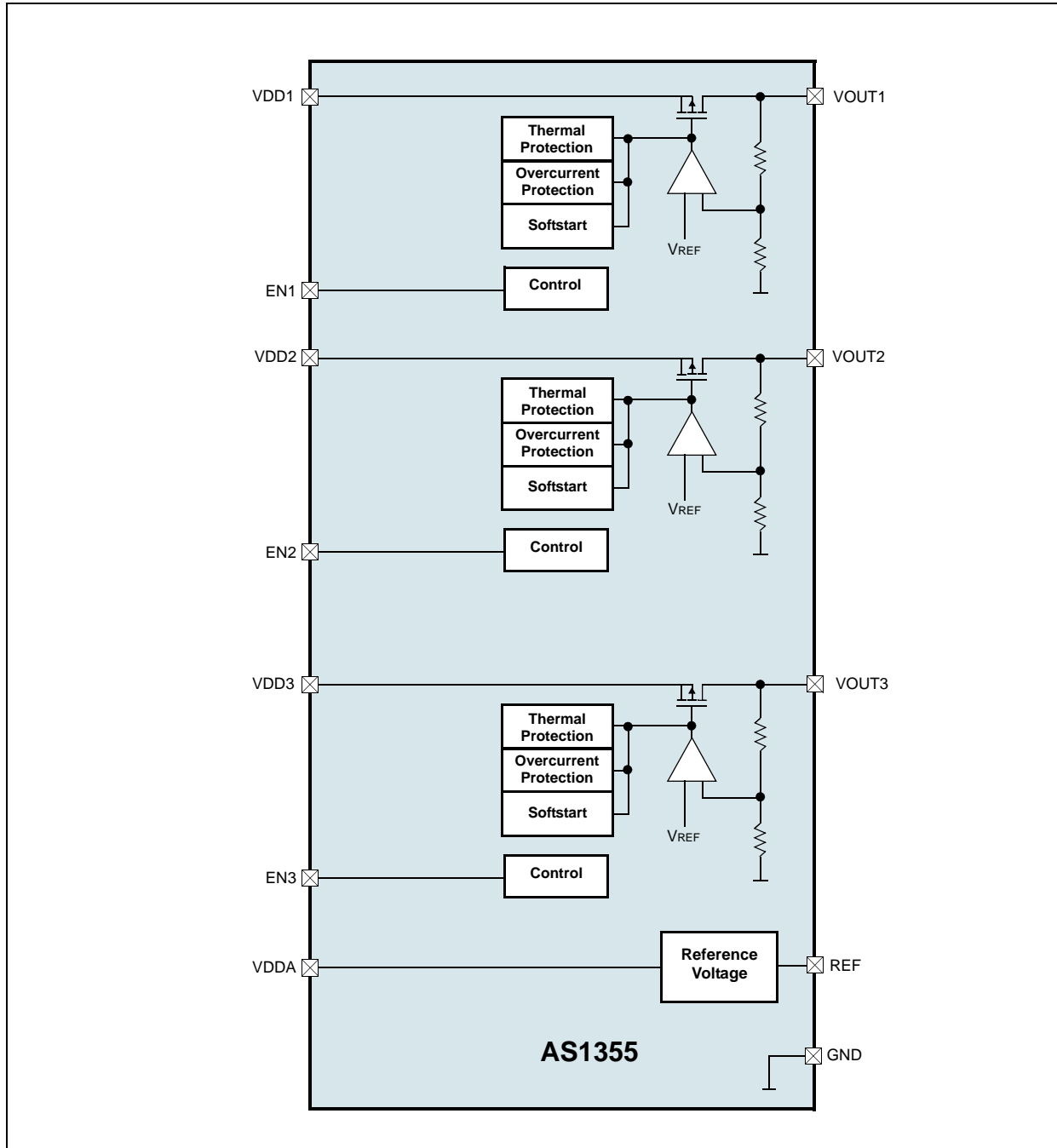

Figure 14. Load Transient Response;  $I_{OUT} = 300$  to  $0mA$



## 8 Detailed Description

Figure 15. AS1355 - Block Diagram





## 10 Package Drawings and Markings

Figure 17. 16-pin QFN 3x3 Marking

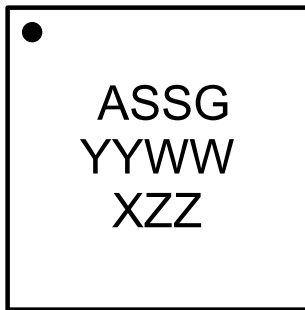
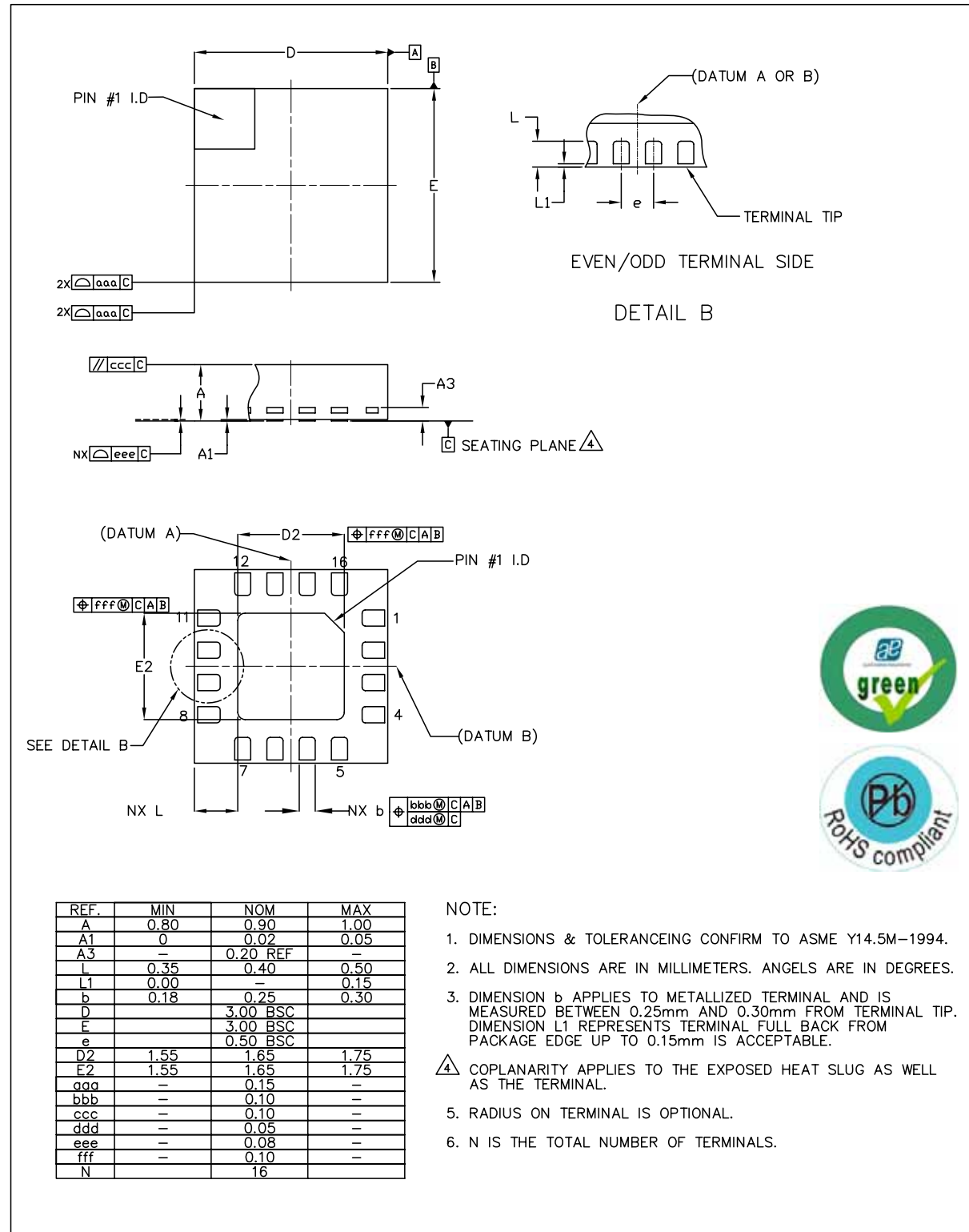

Table 4. Packaging Code YYWWIZZ

YY	WW	X	ZZ
last two digits of the current year	manufacturing week	plant identifier	free choice / traceability code

Figure 18. 16-pin QFN 3x3 Package



			ASSEMBLY ENGINEERING	
a leap ahead in analog			TITLE SAWN QFN, PULL BACK, 3x3x0.9mm, 16 LEAD, 1.65mm SQ. ePAD	REFERENCE DOCUMENT JEDEC MO - 220 LATEST REVISION
DRAWN RHB	DATE 2010.10.29	REV. N/C	DRAWING NO. QSK	UNIT
CHECKED GBO	DATE 2010.10.29	SHEET 1 OF 1	DIMENSION AND TOLERANCE	SCALE NOT IN SCALE
APPROVED MKR	DATE 2010.10.29			

## 11 Ordering Information

The devices are available as the standard products shown in [Table 5](#).

**Table 5. Ordering Information**

Ordering Code	Marking	Output	Description	Delivery Form	Package
AS1355-BQFT-WGD	ASSG	V <sub>OUT1</sub> = 3.3V	300mA, Triple LDO	Tape and Reel	16-pin QFN 3x3
		V <sub>OUT2</sub> = 1.8V			
		V <sub>OUT3</sub> = 1.5V			
AS1355-BQFT-WWW	ASSV	V <sub>OUT1</sub> = 3.3V	300mA, Triple LDO	Tape and Reel	16-pin QFN 3x3
		V <sub>OUT2</sub> = 3.3V			
		V <sub>OUT3</sub> = 3.3V			
AS1355-BQFT-xyz*	—	V <sub>OUT1</sub> *	300mA, Triple LDO	Tape and Reel	16-pin QFN 3x3
		V <sub>OUT2</sub> *			
		V <sub>OUT3</sub> *			

**Note:** All products are RoHS compliant and austriamicrosystems green.

Buy our products or get free samples online at ICdirect: <http://www.austriamicrosystems.com/ICdirect>

Technical Support is found at <http://www.austriamicrosystems.com/Technical-Support>

For further information and requests, please contact us <mailto:sales@austriamicrosystems.com>  
or find your local distributor at <http://www.austriamicrosystems.com/distributo>

\*) These devices are available in factory-set output voltages from 1.25V to 3.6V in 100mV increments. Choose the desired V<sub>OUT</sub> suffix from [Table 6](#) and insert it instead of "xyz" in the part number.

On request also non-standard devices with output voltages between 1.25V and 3.6V in 50mV steps are available.

**Table 6. Output Voltage Suffix Guide**

Suffix	Min	Typ	Max	Suffix	Min	Typ	Max	Suffix	Min	Typ	Max
A		1.25		J		2.1		S		3.0	
B		1.3		K		2.2		T		3.1	
C		1.4		L		2.3		V		3.2	
D		1.5		M		2.4		W		3.3	
E		1.6		N		2.5		X		3.4	
F		1.7		O		2.6		Y		3.5	
G		1.8		P		2.7		Z		3.6	
H		1.9		Q		2.8					
I		2.0		R		2.9					

## Copyrights

Copyright © 1997-2010, austriamicrosystems AG, Tobelbaderstrasse 30, 8141 Unterpremstaetten, Austria-Europe. Trademarks Registered ®. All rights reserved. The material herein may not be reproduced, adapted, merged, translated, stored, or used without the prior written consent of the copyright owner.

All products and companies mentioned are trademarks or registered trademarks of their respective companies.

## Disclaimer

Devices sold by austriamicrosystems AG are covered by the warranty and patent indemnification provisions appearing in its Term of Sale. austriamicrosystems AG makes no warranty, express, statutory, implied, or by description regarding the information set forth herein or regarding the freedom of the described devices from patent infringement. austriamicrosystems AG reserves the right to change specifications and prices at any time and without notice. Therefore, prior to designing this product into a system, it is necessary to check with austriamicrosystems AG for current information. This product is intended for use in normal commercial applications. Applications requiring extended temperature range, unusual environmental requirements, or high reliability applications, such as military, medical life-support or life-sustaining equipment are specifically not recommended without additional processing by austriamicrosystems AG for each application. For shipments of less than 100 parts the manufacturing flow might show deviations from the standard production flow, such as test flow or test location.

The information furnished here by austriamicrosystems AG is believed to be correct and accurate. However, austriamicrosystems AG shall not be liable to recipient or any third party for any damages, including but not limited to personal injury, property damage, loss of profits, loss of use, interruption of business or indirect, special, incidental or consequential damages, of any kind, in connection with or arising out of the furnishing, performance or use of the technical data herein. No obligation or liability to recipient or any third party shall arise or flow out of austriamicrosystems AG rendering of technical or other services.



## Contact Information

Headquarters

austriamicrosystems AG  
Tobelbaderstrasse 30  
A-8141 Unterpremstaetten, Austria

Tel: +43 (0) 3136 500 0  
Fax: +43 (0) 3136 525 01

For Sales Offices, Distributors and Representatives, please visit:

<http://www.austriamicrosystems.com/contact>